

# IDOWN 26

## SPECIFICATIONS

<b>MOUNTING</b>		<b>CEILING RECESSED</b>
POWER	[W]	26
LAMP		built-in LED
LUMINOUS FLUX*	[lm]	2085
LIGHT COLOUR	[K]	3000
CRI		>90
BEAM ANGLE	[°]	30
AVERAGE LIFETIME	[h]	L80/B50.000
LUMINOUS EFFICACY	[lm/W]	80
<b>POWER SUPPLY</b>		700mA CC
LED-DRIVER	[V] [A]	NOT INCLUDED
DIMMING		SEE DRIVER
THROUGH-WIRING		SEE DRIVER
<b>MATERIAL</b>		ALUMINUM
INGRESS PROTECTION		IP54
PROTECTION CLASS		III
NET WEIGHT	[kg]	0,58
GROSS WEIGHT	[kg]	0,60
<b>COLOUR (HOUSING)</b>		OPAL WHITE
CUT-OUT	[mm]	Ø95
RECESSED DEPTH (H)	[mm]	115



## LIGHT DISTRIBUTION

30°

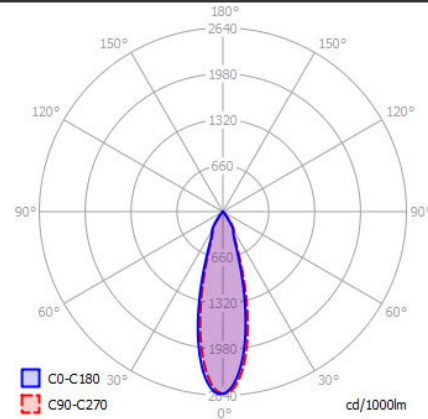

\*Luminous flux values are nominal LED data at a operating temperature of 25° C

## OPTIONS / OPTIONAL ACCESSORIES

15° beam angle on request

## Colours

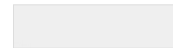

white

## CUT OUT DIMENSIONS

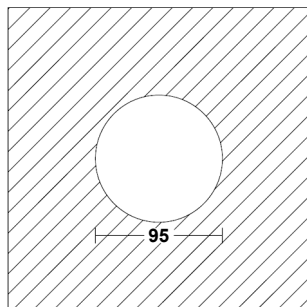

## FIXTURE DIMENSIONS

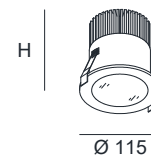

DLS LIGHTING

www.dslighting.com

**\*DLS**  
LIGHTING